

# Suspension System (9/16")

## BENEFITS:

- Hot dipped galvanized coating inhibits red rusting better than electrogalvanized.
- System is engineered and designed to fit and provide high quality finish.
- Main Tee easy profile for installation with Cross Tee.
- Increased strength and stability for improved performance.
- Easy to cut.
- Rotary stitched for additional torsional strength and extra stability during installation.
- Faster and easier insertion/installation of cross tees.
- Tighter tee to tee connection.
- Better load carrying capability.

**Surface Finish**  
Baked polyester paint

**Classification**  
Intermediate heavy duty ID

**Profile**  
Exposed tee system

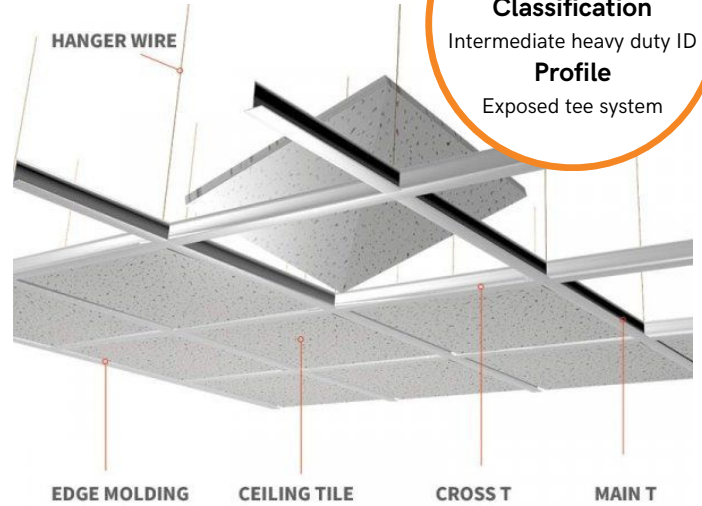

Code	Type	Dimension
#116-38H T-grid (15/16 SYSTEM)	Main T	1 1/2" x 15/16" x 144"
	Cross T	1 1/2" x 15/16" x 24" 1 1/2" x 15/16" x 48"
#116-38H T-grid (9/16 SYSTEM)	Main T	1 1/2" x 9/16" x 144"
	Cross T	1 1/2" x 9/16" x 24" 1 1/2" x 9/16" x 48"
Wall Molding	L shape	25/32" x 25/32" x 142"

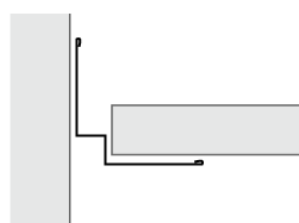
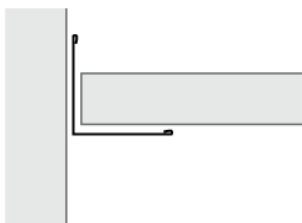
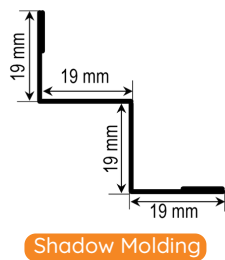
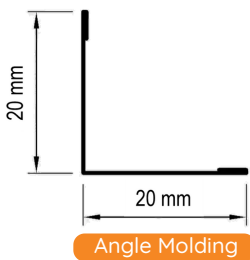
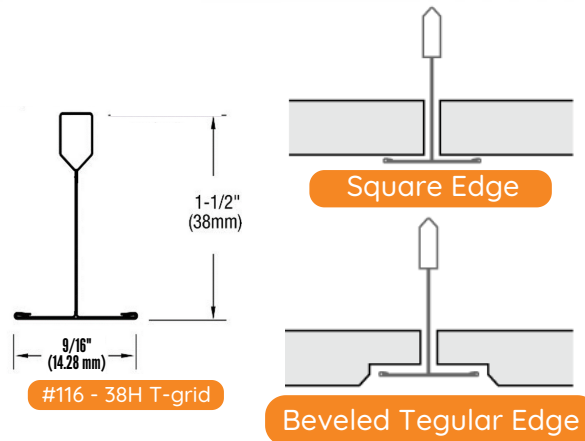

## COLOR CHART

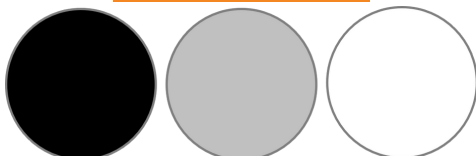

PHYSICAL DATA	
Type	38 H – Heavy Duty Suspension System
Intended use	As a support system in conjunction with various types of Benner Ceiling Tiles and other brands.
End detail	Main tee (12' / HD) Cross Tee (2' / 4' / HD) Wall Angle (HD)
Seismic performance	Compression / tension Main beam – 365 / 7 Cross Tee – 299 / 5
Materials	Components in general galvanized steel cap Fire rated commercial conditions Hot – dipped galvanized steel body
Requirements	Meets with all international code including seismic. Complies with ASTM C635
Application	Applicable to various types of buildings and/or mayor brand ceiling tiles