

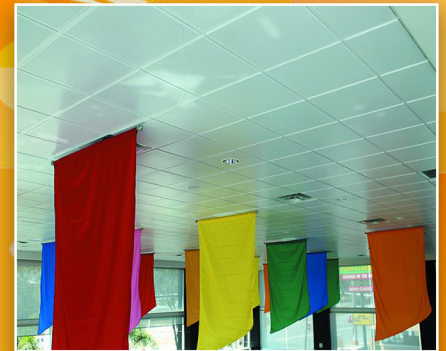

**BENNER  
PRODUCTS**

Manufactures  
Representative

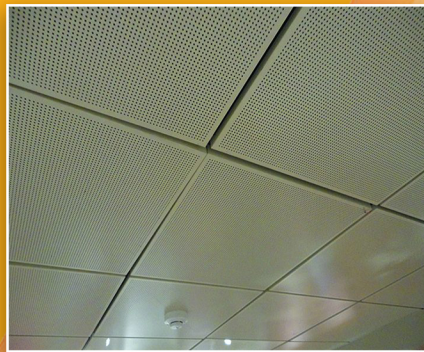

**BENNER ALUMINUM CEILING**

# INDEX



**BENNER  
PRODUCTS**

Manufactures  
Representative

**03 BAC LAY-IN**

**04 BAC CLIP-IN**

**05 BAC LINEAR**

**06 BAC LINEAR G-SHAPE**

**07 BAC LINEAR C & V**

**08 BENNER SUSPENSION**

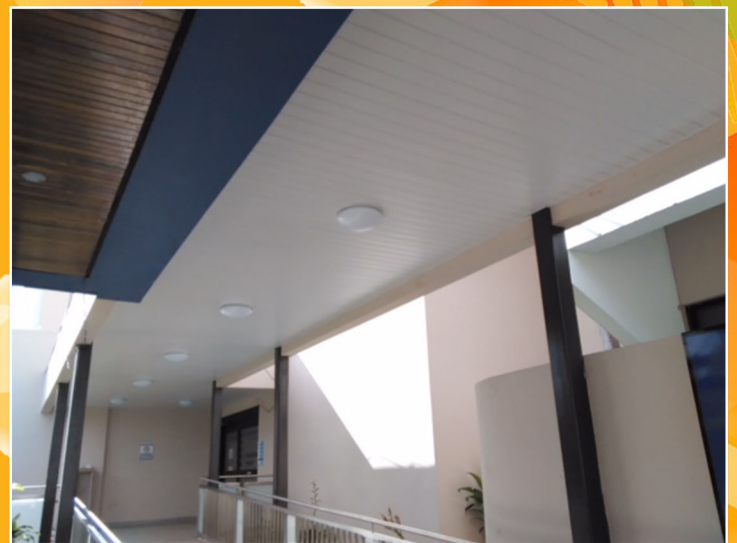

**BENNER ALUMINUM CEILING**

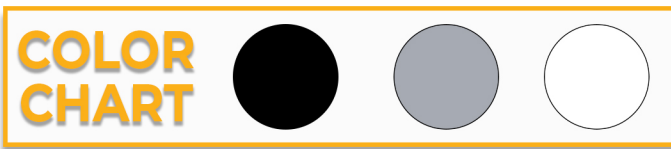
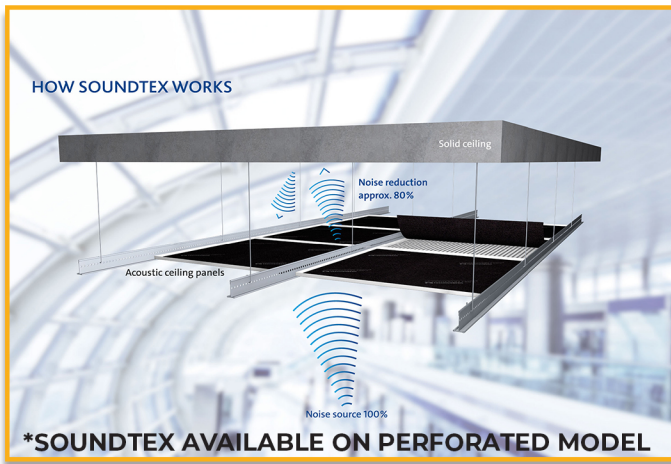
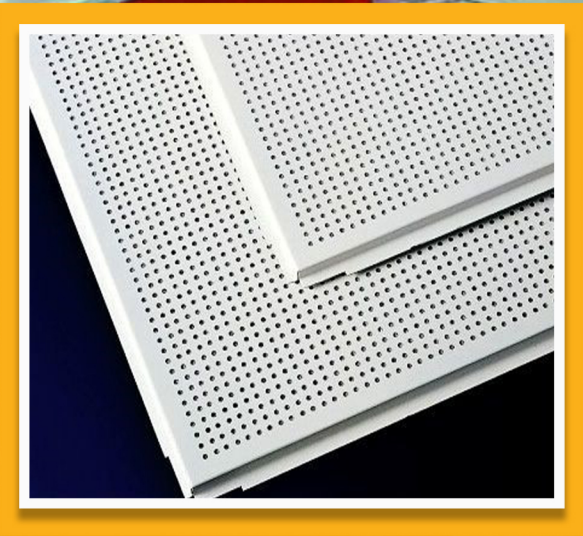

<b>DIMENSIONS:</b>	<b>AS DESIGN REQUIREMENTS</b>
<b>EDGE PROFILE:</b>	<b>LAY-IN</b>
<b>PERFORATION DESIGN:</b>	<b>PATTERN BAC #43</b>
<b>SHAPE:</b>	<b>PANEL</b>
<b>AVAILABLE COLORS:</b>	<b>SEE COLOR CHART ON PAGE</b>
<b>ACOUSTICS NRC:</b>	<b>PERFORATED 0.75 &amp; NON-PERFORATED 0.10</b>
<b>FIRE RESIST / FLAME SPREAD:</b>	<b>CLASS A</b>
<b>LIGHT REFLECTANCE:</b>	<b>0.83</b>
<b>CAC:</b>	<b>UP TO 40</b>
<b>ANTI-MICROBIAL / HUMIDITY RESISTANCE:</b>	<b>VERY HIGH</b>
<b>DURABILITY</b>	<b>IMPACT RESISTANCE</b>
<b>MAINTAINABILITY:</b>	<b>WASHABLE / SCRUBABLE</b>
<b>ACCESSIBILITY:</b>	<b>YES</b>
<b>MATERIAL:</b>	<b>ALUMINIUM</b>
<b>TEXTURE:</b>	<b>SMOOTH</b>
<b>PATTERN:</b>	<b>PERFORATED &amp; NON-PERFORATED</b>
<b>SURFACE FINISH:</b>	<b>POLYESTER POWDER PAINT</b>
<b>ASTM CLASSIFICATION:</b>	<b>TYPE XIII</b>

**PATTERNS OF BENNER ALUMINUM CEILING**



**BAC-#39**



**BAC-#40**



**BAC-#41**

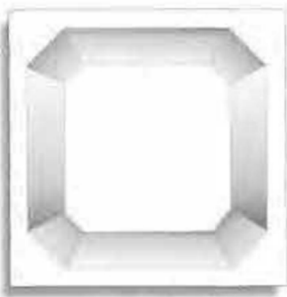

**BAC-#42**

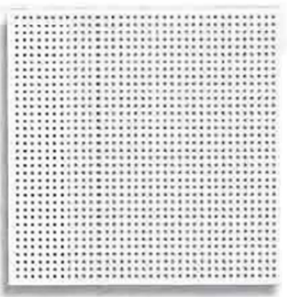

**BAC-#43**

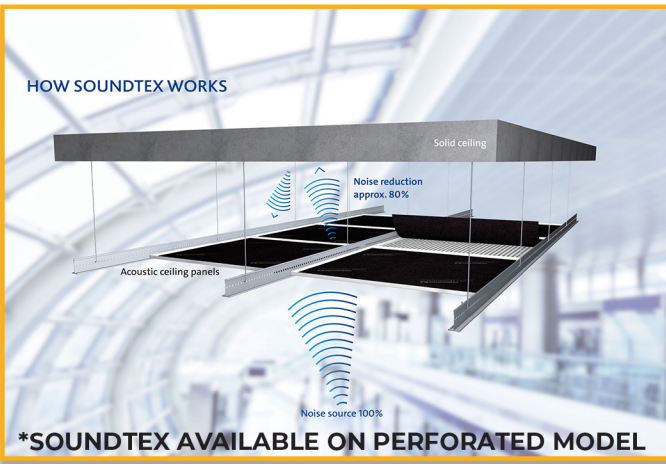

<b>DIMENSIONS:</b>	24" X 48" X 1" 24" X 48" X 1" 48" X 48" X 1"
<b>EDGE PROFILE:</b>	SQUARE
<b>PERFORATION DESIGN:</b>	PATTERN BAC #43
<b>SHAPE:</b>	PANEL
<b>AVAILABLE COLORS:</b>	SEE COLOR CHART ON PAGE
<b>ACOUSTICS NRC:</b>	PERFORATED 0.75 & NON-PERFORATED 0.10
<b>FIRE RESIST / FLAME SPREAD:</b>	CLASS A
<b>LIGHT REFLECTANCE:</b>	0.83
<b>HUMIDITY RESISTANCE:</b>	VERY HIGH
<b>ANTI-MICROBIAL:</b>	VERY HIGH
<b>DURABILITY</b>	IMPACT RESISTANCE
<b>MAINTAINABILITY:</b>	WASHABLE / SCRUBABLE
<b>ACCESSIBILITY:</b>	YES
<b>MATERIAL:</b>	ALUMINIUM
<b>TEXTURE:</b>	SMOOTH
<b>PATTERN:</b>	PERFORATED & NON-PERFORATED
<b>SURFACE FINISH:</b>	POLYESTER POWDER PAINT
<b>ASTM CLASSIFICATION:</b>	TYPE XIII

**PATTERNS OF BENNER ALUMINUM CEILING**



BAC-#39



BAC-#40



BAC-#41

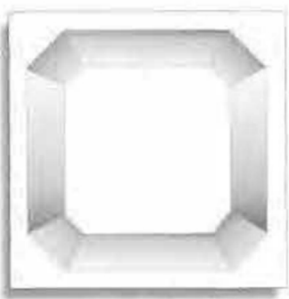

BAC-#42

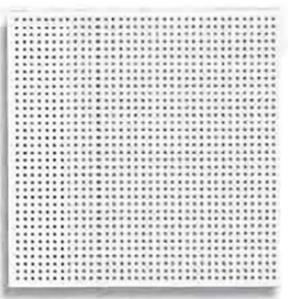

BAC-#43

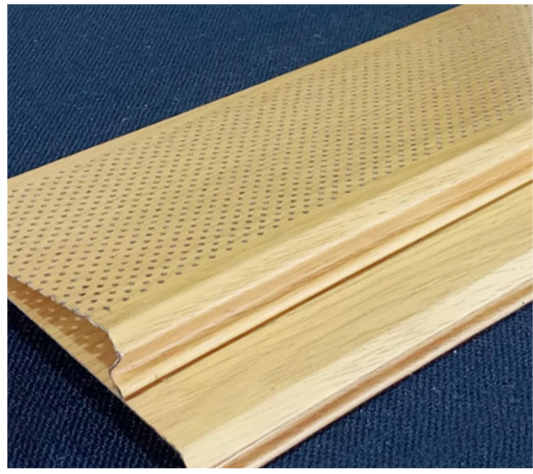

<b>DIMENSIONS:</b>	C-4" TO C-12"
<b>EDGE PROFILE:</b>	SHAPED
<b>PERFORATION DESIGN:</b>	PATTERN BAC #43
<b>SHAPE:</b>	PANEL
<b>AVAILABLE COLORS:</b>	SEE COLOR CHART ON PAGE
<b>ACOUSTICS NRC:</b>	PERFORATED 0.75 & NON-PERFORATED 0.10
<b>FIRE RESIST / FLAME SPREAD:</b>	CLASS A
<b>LIGHT REFLECTANCE:</b>	0.83
<b>CAC:</b>	UP TO 40
<b>ANTI-MICROBIAL / HUMIDITY RESISTANCE:</b>	VERY HIGH
<b>DURABILITY</b>	IMPACT RESISTANCE
<b>MAINTAINABILITY:</b>	WASHABLE / SCRUBABLE
<b>ACCESSIBILITY:</b>	YES
<b>MATERIAL:</b>	ALUMINIUM
<b>TEXTURE:</b>	SMOOTH
<b>PATTERN:</b>	PERFORATED & NON-PERFORATED
<b>SURFACE FINISH:</b>	POLYESTER POWDER PAINT
<b>ASTM CLASSIFICATION:</b>	TYPE XIII

## COLOR CHART

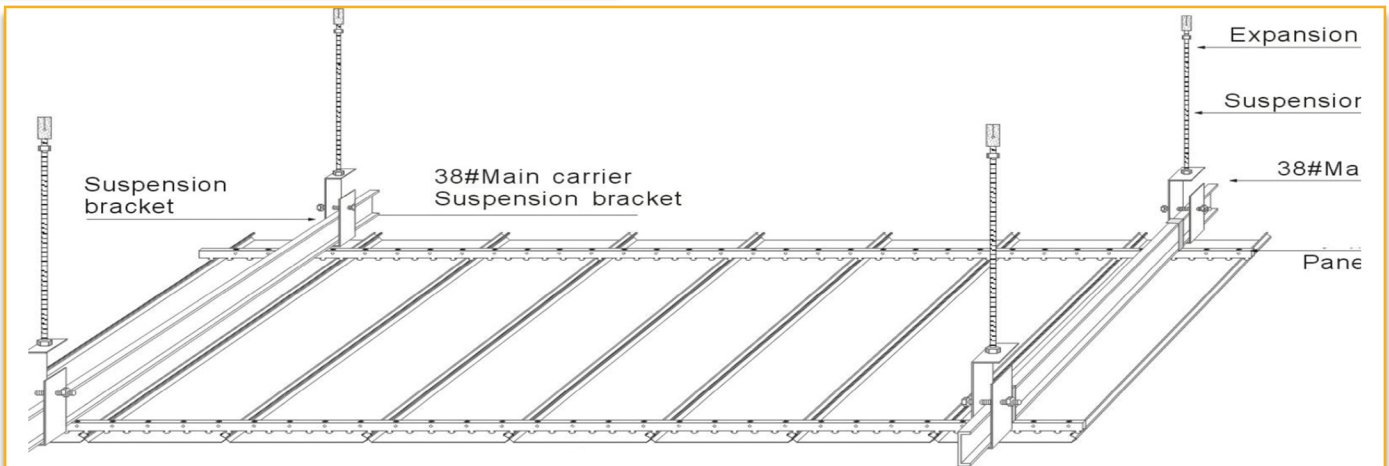

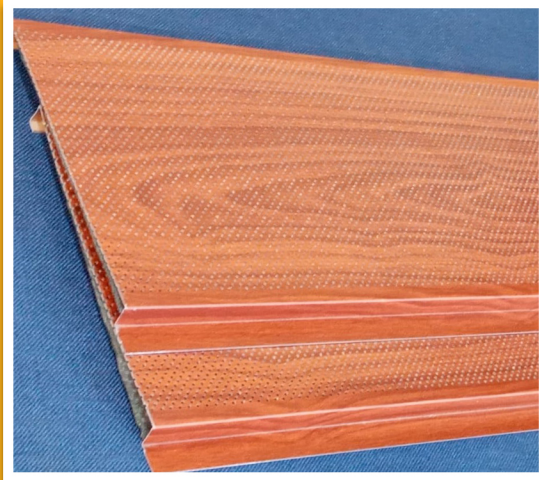

**\*SOUNDTEX AVAILABLE ON PERFORATED MODEL**

<b>DIMENSIONS:</b>	100 X 1000 - 3000 MM 200 X 1000 - 3000 MM 300 X 1000 - 3000 MM
<b>EDGE PROFILE:</b>	G LINEAR
<b>PERFORATION DESIGN:</b>	PATTERN BAC #43
<b>SHAPE:</b>	LINEAR PANEL
<b>AVAILABLE COLORS:</b>	SEE COLOR CHART ON PAGE
<b>ACOUSTICS NRC:</b>	PERFORATED 0.75 & NON-PERFORATED 0.10
<b>FIRE RESIST / FLAME SPREAD:</b>	CLASS A
<b>LIGHT REFLECTANCE:</b>	0.83
<b>CAC:</b>	UP TO 40
<b>ANTI-MICROBIAL / HUMIDITY RESISTANCE:</b>	VERY HIGH
<b>DURABILITY</b>	IMPACT RESISTANCE
<b>MAINTAINABILITY:</b>	WASHABLE / SCRUBABLE
<b>ACCESSIBILITY:</b>	YES
<b>MATERIAL:</b>	ALUMINIUM
<b>TEXTURE:</b>	SMOOTH
<b>PATTERN:</b>	PERFORATED & NON-PERFORATED
<b>SURFACE FINISH:</b>	POLYESTER POWDER PAINT
<b>ASTM CLASSIFICATION:</b>	TYPE XIII

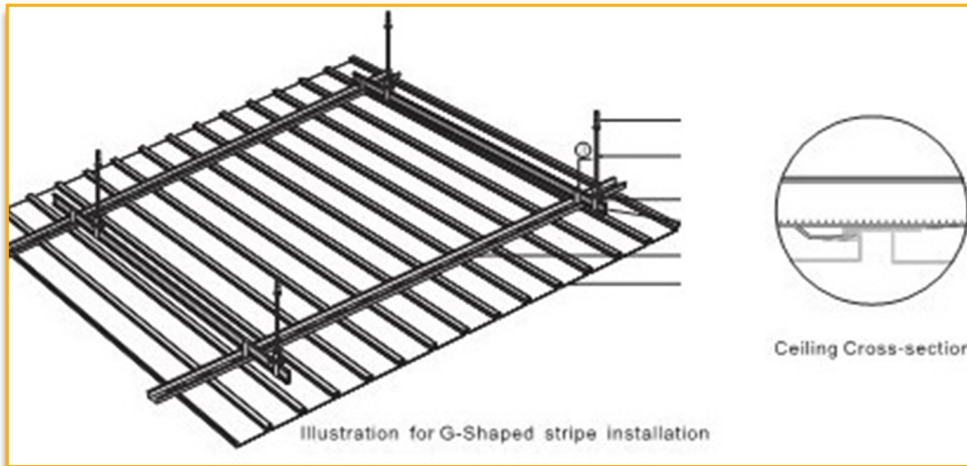
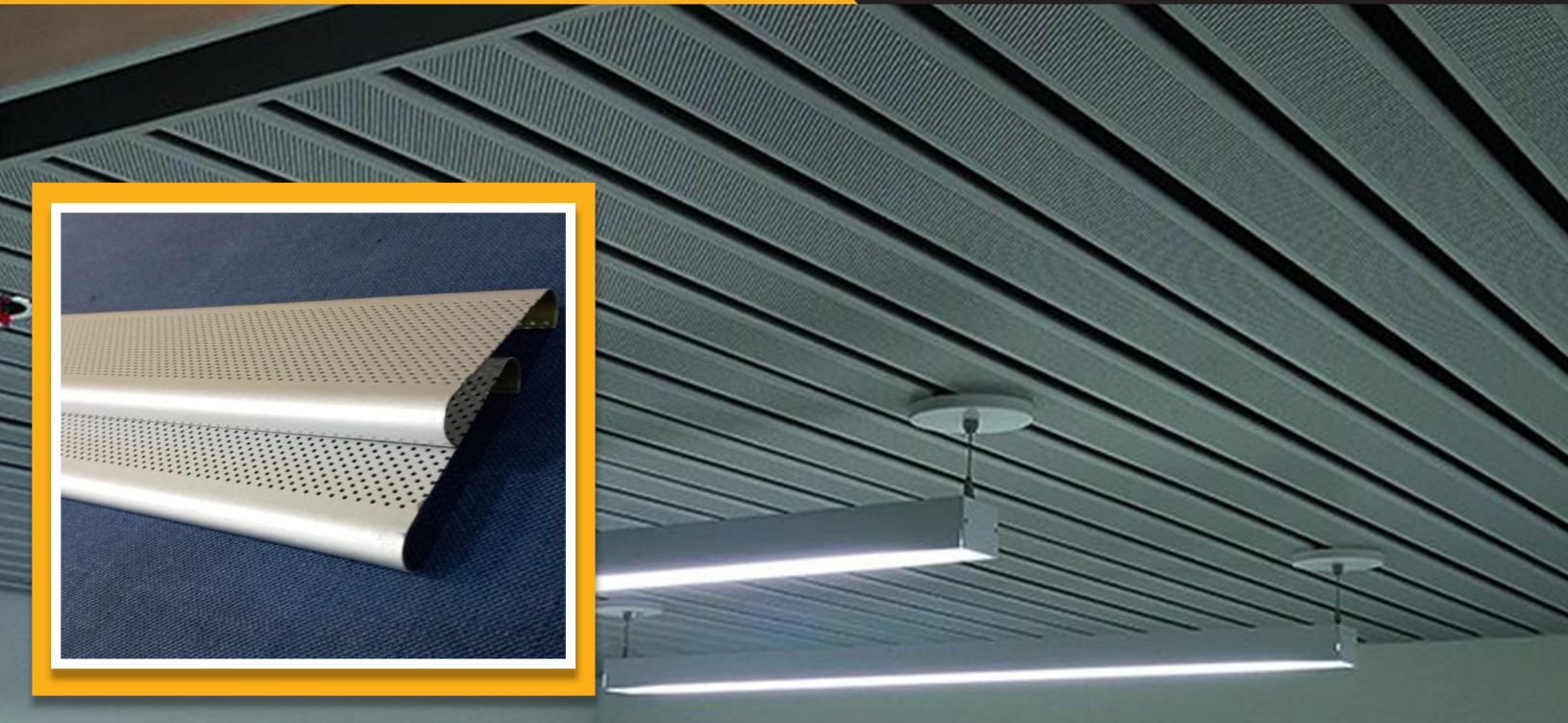
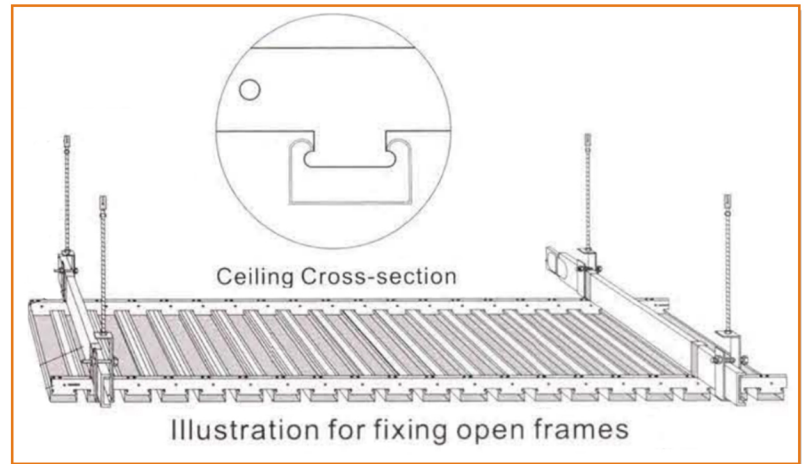
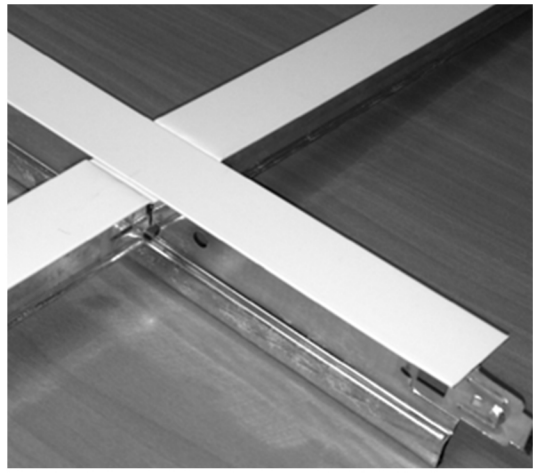

Illustration for G-Shaped stripe installation



<b>DIMENSIONS:</b>	85 X 1000 X 3000 MM 185 X 1000 X 3000 MM
<b>EDGE PROFILE:</b>	C-85, C-185 & V-85, V-185
<b>PERFORATION DESIGN:</b>	PATTERN BAC #43
<b>ACOUSTICS NRC:</b>	PERFORATED 0.75 & NON-PERFORATED 0.10
<b>FIRE RESIST / FLAME SPREAD:</b>	CLASS A
<b>LIGHT REFLECTANCE:</b>	UP TO 0.83
<b>CAC:</b>	UP TO 40
<b>ANTI-MICROBIAL / HUMIDITY RESISTANCE:</b>	VERY HIGH
<b>DURABILITY</b>	IMPACT RESISTANCE
<b>MAINTAINABILITY:</b>	WASHABLE / SCRUBABLE
<b>MATERIAL:</b>	ALUMINIUM
<b>PATTERN:</b>	PERFORATED & NON-PERFORATED
<b>SURFACE FINISH:</b>	POLYESTER POWDER PAINT
<b>ASTM CLASSIFICATION:</b>	TYPE XIII





## Features

Type:

➤ 38H and 32H

Materials:

➤ Components in general galvanized steel cap for use in general and fire rated commercial conditions.

➤ Hot-dipped galvanized steel body.

➤ Meets and exceeds all international code requirements including seismic.

➤ Applicable to various types of buildings.

## Specification

Sectional View	T-grid type	Dimension
	Main T	32mmx24mmx3660mm
	Cross T	25mmx24mmx1220mm 25mmx24mmx610mm
	Main T	38mmx24mmx3660mm
	Cross T	25mmx24mmx1220mm 25mmx24mmx610mm
	L shape	22mmx22mmx3660mm 22mmx19mmx3660mm
	w shape	19mmx19mmx19mmx19mm x3660mm

## COLOR CHART

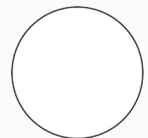
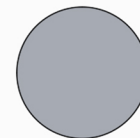

**BENNER**  
SUSPENSION SYSTEM

